

## SENITO

Tasarım | Design : by Masialux

SENITO, minimal tasarımı ve yüksek ışık verimliliğiyle öne çıkan profesyonel bir ray spot armatürüdür. Esnek yönlendirme özelliği ve optimize edilmiş optik yapısı sayesinde mekânlarda net, dengeli ve etkili bir aydınlatma sunar. Dayanıklı yapısı ve uzun ömürlü performansı ile SENITO, modern projeler için şık ve güvenilir bir çözümdür.

SENITO is a professional track spotlight distinguished by its minimalist design and high light efficiency. Its flexible adjustability and optimized optics ensure clear and balanced illumination across various interiors. With its durable construction and long-lasting performance, SENITO provides a stylish and dependable solution for modern lighting projects.

### Özellikler | Properties

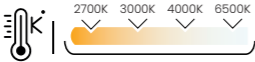
|  |   |
|--|---|
| Gövde   Body                               | : Alüminyum enjeksiyon gövde   Aluminum injection head                              |
| Boyama Tipi   Electrostatic powder coating | : Elektrostatik toz boya   Electrostatic powder coating                             |
| Işık Sıcaklığı   Light Temperature         | :  |
| IP Koruma Sınıfı   IP Protection Class     | : IP 20   |
| Kullanım Şekli   Usage                     | : Ray Spot   Track Spot   |

### Sertifikalar | Certificates

- . CE
- . PTC
- . ISO 9001
- . SASO
- . 3 Yıl Garanti | 3 Year Warranty

Made in  
**Türkiye**

### İstek Üzerine | On request

DALI

## SENITO SERİSİ | SERIES MR 1030-100





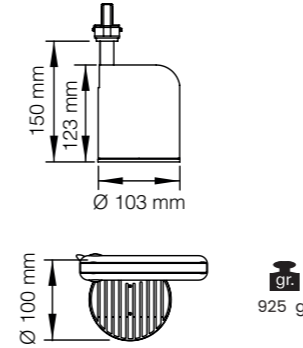









### Teknik Çizim | Technical Drawing



| Model        | Gerilim<br>Voltage | Aktif Güç<br>Active Power | Işık Akısı<br>Luminous Flux | CRI |
|--------------|--------------------|---------------------------|-----------------------------|-----|
| Model .2700K |                    |                           |                             |     |
| MR 1030-100  | 220 V              | 20 W                      | 1943 lm                     | >80 |
| MR 1030-100  | 220 V              | 27 W                      | 2564 lm                     | >80 |

| Model        | Gerilim<br>Voltage | Aktif Güç<br>Active Power | Işık Akısı<br>Luminous Flux | CRI |
|--------------|--------------------|---------------------------|-----------------------------|-----|
| Model .3000K |                    |                           |                             |     |
| MR 1030-100  | 220 V              | 20 W                      | 2039 lm                     | >80 |
| MR 1030-100  | 220 V              | 27 W                      | 2690 lm                     | >80 |
| Model .4000K |                    |                           |                             |     |
| MR 1030-100  | 220 V              | 20 W                      | 2107 lm                     | >80 |
| MR 1030-100  | 220 V              | 27 W                      | 2780 lm                     | >80 |

-  Alüminyum gövde ve reflektör  
Aluminium body and reflector
-  Şeffaf Difüzör  
Transparent Diffuser
-  24° | 38°
-  CRI 80
-  CRI 90
-  220-240V
-  IP 20
-  3 Yıl  
3 Years
-  DALI, Dim Seçeneğiyle  
with DALI, Dim Options
-  Gövde Rengi Seçenekleri  
Body Color Options
-  Siyah  
Black
-  Beyaz  
White
-  RAL

\*Diğer CRI'lar da mevcuttur, lütfen danışın. | Other CRI available, please consult.

\*Katalogta yer alan tüm ölçü ve teknik değerler nominal değerler olup ±%10 tolerans gösterebilir. | All dimensions and technical data provided in the catalogue are nominal values and may vary within a ±10% tolerance.