

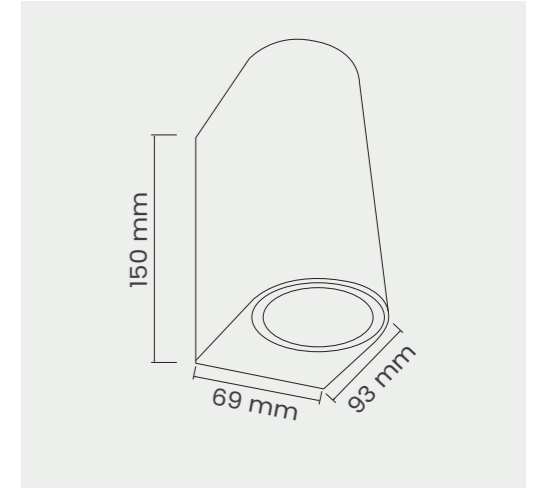

## JIWA SERİSİ | SERIES

ÇİFT YÖNLÜ DUVAR APLİK | BIDIRECTIONAL APPLIQUE



## MO 133

Tasarım | Design : by Masialux

Özellikler | Properties

Gövde   Body	: Alüminyum enjeksiyon gövde   Aluminum injection head
Işık Sıcaklığı   Light Temperature	: 2700 K   3000 K   4000 K   6500 K
IP Koruma Sınıfı   IP Protection Class	: IP 44
Kullanım Şekli   Usage	: Aplik   Applique
Işık Kaynağı   Source of Light	: GU Ampul   GU 10 Bulb
Duy Tipi   Lampholder Type	: 2 x GU 10
Montaj Tipi   Mounting Type	: Duvar   Wall

2700 K | 3000 K | 4000 K | 6500 K

IP 44

DALI, Dim Seçeneğiyle  
with DALI, Dim Options



Made in  
Türkiye

Gövde Rengi Seçenekleri  
Body Color Options

Siyah  
Black

Beyaz  
White

masialux

www.masialux.com